

MADE IN DENMARK



EDGE BY HAMMEL

Vejl. prislister DKK inkl. moms



Ret til ændringer forbeholdes
2021/3

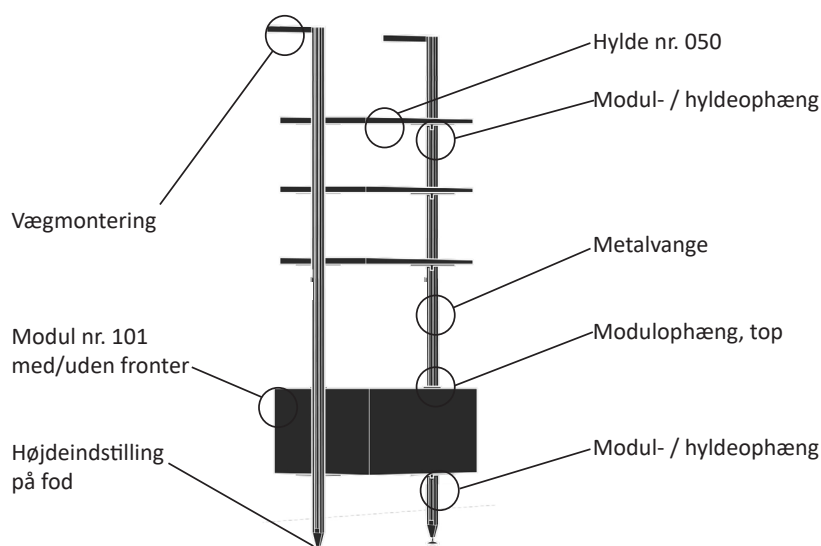

hammel®

Modul	Vangereol		Mål i cm	Sort	Hvid
400		Vangereol basismodul. Leveres inkl.: 2 metalvange, murmontering, beslag til brug for 4 hylde eller til 3 hylde og 1 skab. Højdejusterbar. Tilbehør se side 3.	B: 2,5 H: 210 D: 22 Kg: 5,3 m ³ : 0,013	40 08 0400 2580	40 07 0400 2580
401		Vangereol tilbygningsmodul. Leveres inkl.: 1 metalvange, murmontering, beslag til brug for 4 hylde eller til 3 hylde og 1 skab. Højdejusterbar. Tilbehør se side 3.	B: 2,5 H: 210 D: 22 Kg: 3,3 m ³ : 0,009	40 08 0401 1791	40 07 0401 1791



Modul	Vangereol		Mål i cm	Sort	Hvid
420		Til ekstra modul- / hyldeophæng. Pulverlakeret i sort eller hvid.	B: 2,5 H: 4,5 D: 16 Kg: 0,1 m ³ : 0,002	40 08 0420 158	40 07 0420 158
421		Til ekstra modulophæng, top. Til ét ekstra skab skal der bruges 1x420 og 1x421. Pulverlakeret i sort eller hvid.	B: 2 H: 4 D: 5,3 Kg: 0,1 m ³ : 0,001	40 08 0421 129	40 07 0421 129
422		Bøjlestang inkl. 2 afstandsstykker. Total dybde 30cm. Med gummikant for oven. Pulverlakeret i sort eller hvid.	B: 90 H: 3,5 D: 1,2 Kg: 1,4 m ³ : 0,004	40 08 0422 717	40 07 0422 717



1x400*4x050



1x400*1x401*3x050*4x051
+1x101*1x012*2x011



1x400*1x422*1x101*4x011
+1x050



1x400*2x401*10x050*2x101*2x012*4x011















EDGE BY HAMMEL

Max kg = max anbefalet totalvægt
for indhold i og ovenpå væghængt modul.

Vejl. prisliste DKK

Pris gr. 1 (xx)	Pris gr. 2 (xx)	Pris gr. 3 (xx)
81 snehvid	Grundmoduler + hylder: 16 røget eg 75 sort bejdsset Fronter: 15 hvidpigm. eg* 16 røget eg 75 sort bejdsset *mat lak	72 sort 82 antracit 95 grafit 98 cappuccino

Varenr. struktur:
EKS: skab nr. 100 i sort:
40 72 0100

Modul	Moduler til vangereol		Mål i cm	Prisgr.1	Prisgr.2	Prisgr.3
050		5 MAX kg	Hylde til vangereol til 1 sektion. Ved mere end 4 hylder, husk at tilkøbe beslag nr. 420.	B: 89,0 H: 1,9 D: 32,5 Kg: 5,0 m ³ : 0,009	40 xx 0050 659	40 xx 0050 860 789
051		5 MAX kg	Hylde til vangereol til 1/2 sektion. Ved mere end 4 hylder, husk at tilkøbe beslag nr. 420.	B: 44,5 H: 1,9 D: 32,5 Kg: 2,4 m ³ : 0,005	40 xx 0051 373	40 xx 0051 459 488
211		20 MAX kg	Skrivepult. Inkl. metalstang, skillerum, hylde, skriveunderlag. Med kabelhul i bunden. Skuffe under klappen.	B: 90,8 H: 46,2 D: 32,5 Kg: 30,6 m ³ : 0,213	40 xx 0211 6163	40 xx 0211 7151 Fås i farve 16+75 7295
101		40 MAX kg	Skab. Til montering i vangereol.	B: 90,8 H: 46,2 D: 32,5 Kg: 18,7 m ³ : 0,213	40 xx 0101 2150	40 xx 0101 2580 2637
100		20 MAX kg	Skab. Til montering i vangereol.	B: 46,2 H: 46,2 D: 32,5 Kg: 10,8 m ³ : 0,116	40 xx 0100 1863	40 xx 0100 2150 2222
102		20 MAX kg	Skab inkl. 1 hylde. Til montering i vangereol.	B: 46,2 H: 90,8 D: 32,5 Kg: 18,2 m ³ : 0,215	40 xx 0102 2150	40 xx 0102 2580 2637
010		5 MAX kg	Hylde til modul 100 + 101 + 102.	B: 42,3 H: 1,7 D: 28,05 Kg: 1,5 m ³ : 0,004	40 xx 0010 286	40 xx 0010 343 358
011		10 MAX kg	Skuffe til modul 100 + 101 + 102. Med pushåbning og fuldt udtræk.	B: 44,4 H: 22 D: 26,7 Kg: 5,1 m ³ : 0,057	40 xx 0011 1418	40 xx 0011 1490 1505
012			Dør til modul 100 + 101 + 102. Med pushåbning.	B: 44,4 H: 44,4 D: 1,7 Kg: 2,8 m ³ : 0,011	40 xx 0012 644	40 xx 0012 932 1003
013			Høj dør til 102. Med pushåbning.	B: 89,2 H: 44,4 D: 1,7 Kg: 5,2 m ³ : 0,022	40 xx 0013 860	40 xx 0013 1075 1132
021			Lav klap til 101. Med pushåbning.	B: 89,2 H: 22 D: 1,7 Kg: 3,0 m ³ : 0,013	40 xx 0021 1290	40 xx 0021 1576 1648
014			Høj klap til 101. Med pushåbning.	B: 89,2 H: 44,4 D: 1,7 Kg: 5,6 m ³ : 0,022	40 xx 0014 1576	40 xx 0014 1863 1935
022 023 035			Lav stofklap til 101. Med pushåbning.	B: 89,2 H: 22,0 D: 1,7 Kg: 2,1 m ³ : 0,013	40 05 0022 1863 sort	40 05 0023 2222 grafit 40 05 0035 2222 hvid
015 016 036			Høj stofklap til 101. Med pushåbning.	B: 89,2 H: 44,4 D: 1,7 Kg: 3,1 m ³ : 0,022	40 05 0015 2007 sort	40 05 0016 2651 grafit 40 05 0036 2651 hvid

















Max kg = max anbefalet totalvægt
for indhold i og ovenpå væghængt modul.

Vejl. prisliste DKK

Pris gr. 1 (xx)	Pris gr. 2 (xx)	Pris gr. 3 (xx)
81 snehvid	Grundmoduler + hylder: 16 røget eg 75 sort bejdset Fronter: 15 hvidpig. eg* 16 røget eg 75 sort bejdset *mat lak	72 sort 82 antracit 95 grafit 98 cappuccino

Varenr. struktur:
EKS: skab nr. 100 i sort:
40 72 0100

Modul	Grundmoduler D: 32,5 cm	Mål i cm	Prisgr.1	Prisgr.2	Prisgr.3
100	 20 MAX kg Skab. Ved ben: anvend min. 4 stk.	B: 46,2 H: 46,2 D: 32,5 Kg: 10,8 m ³ : 0,116	40 xx 0100 1863	40 xx 0100 2150	40 xx 0100 2222
101	 40 MAX kg Skab. Ved ben: anvend min. 4 stk.	B: 90,8 H: 46,2 D: 32,5 Kg: 18,7 m ³ : 0,213	40 xx 0101 2150	40 xx 0101 2580	40 xx 0101 2637
211	 20 MAX kg Skrivepult. Inkl. metalstang, skillerum, hylde, skriveunderlag. Med kabelhul i bunden. Skuffe under klappen.	B: 90,8 H: 46,2 D: 32,5 Kg: 30,6 m ³ : 0,213	40 xx 0211 6163	40 xx 0211 7151 Fås i farve 16+75	40 xx 0211 7295
102	 20 MAX kg Skab inkl. 1 hylde. Ved ben: anvend min. 4 stk.	B: 46,2 H: 90,8 D: 32,5 Kg: 18,2 m ³ : 0,215	40 xx 0102 2150	40 xx 0102 2580	40 xx 0102 2637
103	 40 MAX kg Skab inkl. 2 hylder. Ved ben: anvend min. 4 stk.	B: 90,8 H: 90,8 D: 32,5 Kg: 30,0 m ³ : 0,394	40 xx 0103 2580	40 xx 0103 3297	40 xx 0103 3368
052	 Bagklædning til skab 103. Inkl. monteringsbeslag. Så modulet kan anvendes fritstående.	B: 90,3 H: 1,2 D: 90,3 Kg: 8,2 m ³ : 0,024	40 xx 0052 1233		40 xx 0052 1361
Modul	Tilbehør til D: 32,5	Mål i cm	Prisgr.1	Prisgr.2	Prisgr.3
010	 5 MAX kg Hylde til modul 100 + 101 + 102 + 103.	B: 42,3 H: 1,7 D: 28,05 Kg: 1,5 m ³ : 0,004	40 xx 0010 286	40 xx 0010 343	40 xx 0010 358
011	 10 MAX kg Skuffe til modul 100 + 101 + 102 + 103. Med pushåbning og fuldt udtræk.	B: 44,4 H: 22 D: 26,7 Kg: 5,1 m ³ : 0,057	40 xx 0011 1418	40 xx 0011 1490	40 xx 0011 1505
012	 Dør til modul 100 + 101 + 102 + 103. Med pushåbning.	B: 44,4 H: 44,4 D: 1,7 Kg: 2,8 m ³ : 0,011	40 xx 0012 644	40 xx 0012 932	40 xx 0012 1003
013	 Høj dør til 102 + 103. Med pushåbning.	B: 89,2 H: 44,4 D: 1,7 Kg: 5,2 m ³ : 0,022	40 xx 0013 860	40 xx 0013 1075	40 xx 0013 1132
021	 Lav klap til 101 + 103. Med pushåbning.	B: 89,2 H: 22,0 D: 1,7 Kg: 3,0 m ³ : 0,013	40 xx 0021 1290	40 xx 0021 1576	40 xx 0021 1648
014	 Høj klap til 101 + 103 Med pushåbning. 103: For montering i bund, monteres push-beslag i siden af modulet.	B: 89,2 H: 44,4 D: 1,7 Kg: 5,6 m ³ : 0,022	40 xx 0014 1576	40 xx 0014 1863	40 xx 0014 1935
022 023 035	 Lav stofklap til 101 + 103. Med pushåbning.	B: 89,2 H: 22,0 D: 1,7 Kg: 2,1 m ³ : 0,013	40 05 0022 1863 sort	40 05 0023 2222 gråfit	40 05 0035 2222 hvid
015 016 036	 Høj stofklap til 101 + 103. Med pushåbning. 103: For montage i bund, monteres push-beslag i siden af modulet.	B: 89,2 H: 44,4 D: 1,7 Kg: 3,1 m ³ : 0,022	40 05 0015 2007 sort	40 05 0016 2651 gråfit	40 05 0036 2651 hvid
Modul	Grundmoduler alm. Samling D: 32,5 cm	Mål i cm	Prisgr.1	Prisgr.2	Prisgr.3
300	 20 MAX kg Reol inkl. 2 hylder. Ved ben: anvend min. 4 stk. NB: ben 174+176 kan IKKE anvendes. Der findes ingen fronter til modul 300.	B: 23,8 H: 127,2 D: 32,5 Kg: 12,1 m ³ : 0,165	40 xx 0300 2293	40 xx 0300 2794	40 xx 0300 2866









EDGE BY HAMMEL

Max kg = max anbefalet totalvægt
for indhold i og ovenpå væghængt modul.

Vejl. prisliste DKK

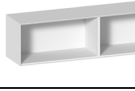
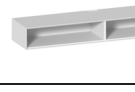
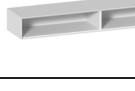
Pris gr. 1 (xx)	Pris gr. 2 (xx)	Pris gr. 3 (xx)
81 snehvid	Grundmoduler + hylder: 16 røget eg 75 sort bejdet Fronter: 15 hvidpigm. eg* 16 røget eg 75 sort bejdet *mat lak	72 sort 82 antracit 95 grafit 98 cappuccino

Varenr. struktur:
EKS: skab nr. 100 i sort:
40 72 0100

Modul	Grundmoduler D: 42 cm		Mål i cm	Prisgr.1	Prisgr.2	Prisgr.3
104		40 MAX kg	B: 90,8 H: 90,8 D: 42 Kg: 37,7 m ³ : 0,492	40 xx 0104 3152	40 xx 0104 3726	40 xx 0104 3869
052			B: 90,3 H: 1,2 D: 90,3 Kg: 8,2 m ³ : 0,024	40 xx 0052 1233		40 xx 0052 1361
207		20 MAX kg	B: 90,8 H: 24,0 D: 42 Kg: 17,5 m ³ : 0,152	40 xx 0207 2580	40 xx 0207 2923	40 xx 0207 3038
208		20 MAX kg	B: 90,8 H: 46,2 D: 42 Kg: 21,0 m ³ : 0,261	40 xx 0208 2637	40 xx 0208 3009	40 xx 0208 3081
203		20 MAX kg	B: 180,4 H: 46,2 D: 42 Kg: 45,7 m ³ : 0,502	40 xx 0203 4013	40 xx 0203 4873	40 xx 0203 4944
204		20 MAX kg	B: 180,4 H: 46,2 D: 42 Kg: 45,7 m ³ : 0,502	40 xx 0204 4299	40 xx 0204 5159	40 xx 0204 5231
205		20 MAX kg	B: 180,4 H: 24 D: 42 Kg: 32,9 m ³ : 0,292	40 xx 0205 3726	40 xx 0205 4586	40 xx 0205 4658
206		20 MAX kg	B: 180,4 H: 24,0 D: 42 Kg: 32,9 m ³ : 0,292	40 xx 0206 4013	40 xx 0206 4873	40 xx 0206 4944
212		100 MAX kg	B: 225,8 H: 46,2 D: 42 Kg: 47,8 m ³ : 0,626	40 xx 0212 5165		40 xx 0212 6363
500		40 MAX kg	B: 179,9 H: 59,0 D: 42 Kg: 51,8 m ³ : 0,535	40 xx 0500 4586	40 xx 0500 5732	40 xx 0500 5805
053			B: 179,2 H: 1,2 D: 58,3 Kg: 10,5 m ³ : 0,030	40 xx 0053 1376		40 xx 0053 1505
501		20 MAX kg	B: 120,4 H: 59,0 D: 42 Kg: 31,8 m ³ : 0,428	40 xx 0501 3798	40 xx 0501 4944	40 xx 0501 5016

hammel tegneprogram

Prøv tegneprogrammet fra Hammel. Her kan du nemt designe din egen opstilling på tablet, mobil eller computer.

Find link til tegneprogrammet på:
www.hammel-furniture.dk/tegneprogram.aspx
Eller download vores app: Hammel

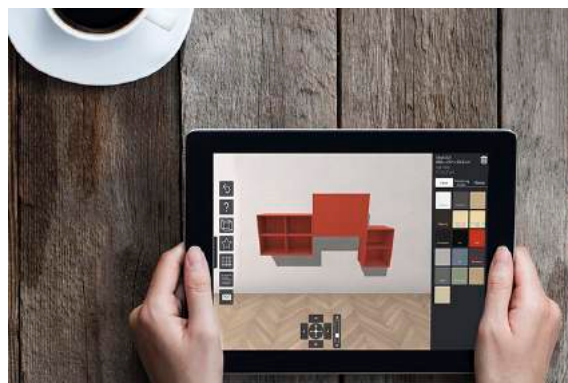























Max kg = max anbefalet totalvægt
for indhold i og ovenpå væghængt modul.

Vejl. prisliste DKK

Varenr. struktur:
EKS: skab nr. 100 i sort:
40 72 0100

Pris gr. 1 (xx)	Pris gr. 2 (xx)	Pris gr. 3 (xx)
81 snehvid	Grundmoduler + hylder: 16 røget eg 75 sort bejdset Fronter: 15 hvidpig. eg* 16 røget eg 75 sort bejdset *mat lak	72 sort 82 antracit 95 grafit 98 cappuccino

Modul	Tilbehør til D: 42		Mål i cm	Prisgr.1	Prisgr.2	Prisgr.3
033		5 MAX kg	Hylde til modul 104 + 212. B: 42,3 H: 1,7 D: 37,65 Kg: 2,1 m³: 0,006	40 xx 0033 315	40 xx 0033 373	40 xx 0033 402
019		5 MAX kg	Hylde til modul 203 + 204 + 205 + 206 + 207 + 208 + 212. B: 87,1 H: 1,7 D: 37,65 Kg: 4,0 m³: 0,009	40 xx 0019 573	40 xx 0019 659	40 xx 0019 673
031		5 MAX kg	Hylde til modul 500 + 501. B: 57,0 H: 1,7 D: 37,65 Kg: 2,9 m³: 0,006	40 xx 0031 573	40 xx 0031 659	40 xx 0031 673
032		10 MAX kg	Skuffe til modul 104 + 212. Med pushåbning og med fuldt udtræk. B: 44,4 H: 22 D: 36,7 Kg: 5,9 m³: 0,072	40 xx 0032 1490	40 xx 0032 1562	40 xx 0032 1591
020		10 MAX kg	Skuffe til modul 203 + 204 + 205 + 206 + 207 + 208 + 209 + 212. Med pushåbning og med fuldt udtræk. B: 89,6 H: 22,0 D: 36,7 Kg: 8,9 m³: 0,136	40 xx 0020 1576	40 xx 0020 1706	40 xx 0020 1719
024		10 MAX kg	Skuffe til modul 500 + 501. Med pushåbning og med fuldt udtræk. B: 59,1 H: 18,8 D: 36,7 Kg: 6,2 m³: 0,082	40 xx 0024 1418	40 xx 0024 1490	40 xx 0024 1505
012			Dør til modul 104 + 212. Med pushåbning. B: 44,4 H: 44,4 D: 1,7 Kg: 2,8 m³: 0,011	40 xx 0012 644	40 xx 0012 932	40 xx 0012 1003
013			Høj dør til 104. Med pushåbning. B: 89,2 H: 44,4 D: 1,7 Kg: 5,2 m³: 0,022	40 xx 0013 860	40 xx 0013 1075	40 xx 0013 1132
025			Dør til 500 + 501. Med pushåbning. B: 59,1 H: 57,1 D: 1,7 Kg: 4,4 m³: 0,018	40 xx 0025 860	40 xx 0025 1075	40 xx 0025 1132
026 027 037			Stof dør til 500 + 501. Med pushåbning. B: 59,1 H: 57,1 D: 1,7 Kg: 2,1 m³: 0,018	40 05 0026 1390 sort	40 05 0027 1820 grafit	40 05 0037 1820 hvid
021			Lav klap til 104 + 203 + 204 + 205 + 206 + 207 + 208 + 212. Med pushåbning. B: 89,2 H: 22,0 D: 1,7 Kg: 3,0 m³: 0,013	40 xx 0021 1290	40 xx 0021 1576	40 xx 0021 1648
014			Høj klap til 104 + 203 + 204 + 208 + 212. Med pushåbning. B: 89,2 H: 44,4 D: 1,7 Kg: 5,6 m³: 0,022	40 xx 0014 1576	40 xx 0014 1863	40 xx 0014 1935
022 023 035			Lav stofklap til modul 104+203+204 + 205+206+207+208+212. Med pushåbning. B: 89,2 H: 22,0 D: 1,7 Kg: 2,1 m³: 0,013	40 05 0022 1863 sort	40 05 0023 2222 grafit	40 05 0035 2222 hvid
015 016 036			Høj stofklap til 104 + 203 + 204 + 208+212. Med pushåbning. B: 89,2 H: 44,4 D: 1,7 Kg: 3,1 m³: 0,022	40 05 0015 2007 sort	40 05 0016 2651 grafit	40 05 0036 2651 hvid

Modul	Hjul og ben		Mål i cm		
177		Stillefødder, 6 stk. Kan monteres under alle grundmoduler.	B: 2,8 H: 3,0 D: 2,8 Kg: 0,2 m ³ : 0,001	10 20 0177	265
187		Rustik hjul, 6 stk. heraf 2 stk. med bremses. Kan monteres under alle grundmoduler.	B: 3,5 H: 12,0 D: 10,5 Kg: 2,3 m ³ : 0,008	10 20 0187	819
174 176		Metalben, 4 stk. Kan monteres under alle grundmoduler. Husk støtteben 198/199 ved moduler med en bredde på mere end 91 cm.	B: 22,0 H: 20,0 D: 2,0 Kg: 2,1 m ³ : 0,011	10 20 0174	10 20 0176
198 199		Støtteben, 1 stk. Til brug ved moduler over 91 cm. Kan justeres fra 14- 20 cm.	B: 20,0 H: 20,0 D: 2,0 Kg: 0,4 m ³ : 0,009	10 20 0198	10 20 0199
256		Metal sokkel til skab nr. 104. Fås i hvid og sort pulverlak.	B: 86,0 H: 30,0 D: 38,5 Kg: 3,8 m ³ : 0,009	40 08 0256	40 07 0256
257		Metal sokkel til skab nr. 500+205+206+203+204. Fås i hvid og sort pulverlak.	B: 176,0 H: 30,0 D: 38,5 Kg: 5,3 m ³ : 0,017	40 08 0257	40 07 0257
Modul	Væghylde		Mål i cm		
450 452	 5 MAX kg	Metal hylde. Pulverlakeret i sort eller hvid.	B: 65,0 H: 18,9 D: 27,0 Kg: 2,7 m ³ : 0,007	10 20 0450	10 20 0452
451 453	 5 MAX kg	Metal hylde. Pulverlakeret i sort eller hvid.	B: 65,0 H: 13,1 D: 17,0 Kg: 2,0 m ³ : 0,007	10 20 0451	10 20 0453

Få yderligere information i vores EDGE by Hammel brochure.
Her finder du inspiration til spændende EDGE by Hammel løsninger.

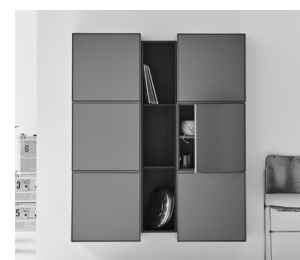
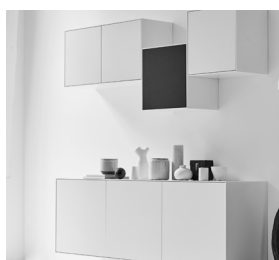
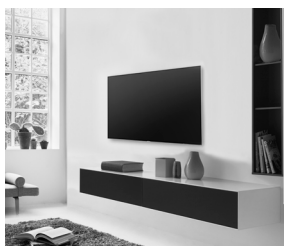

Se disse og flere opstillinger i vores tegneprogram under  Galleri.



hammel®

www.hammel-furniture.dk - facebook.com/byhammel - [instagram @byhammel](https://instagram.com/byhammel) - sales@hammel-furniture.dk